

NOTES:

1. MATERIAL: .032 THICK NICKEL PLATED STEEL
#3 TEMPER (1/4 HARD)
PER ETCO METAL CODE XXXXX.
2. PARTS MAY BE COATED WITH A LIGHT FILM OF LUBRICATION USED IN THE MANUFACTURING PROCESS.
3. PARTS ARE PRODUCED IN LOOSE PIECE FORM.

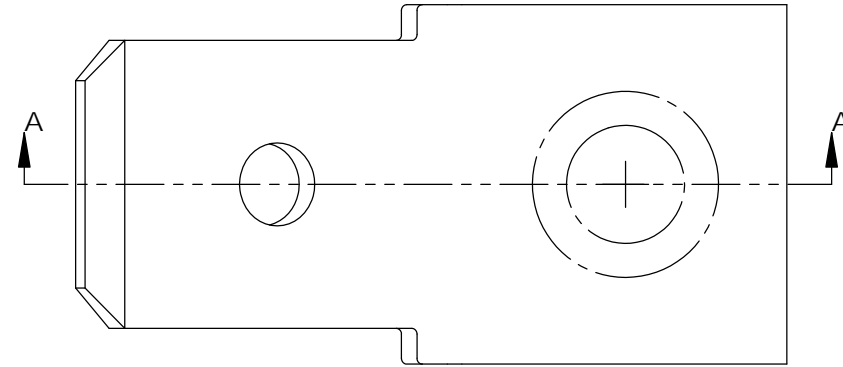

Part Number	Mat'l
3000M 292C3	Note 1

Rev.	Description of Change/ SCN#	Date
-	Approved For Quote SCJ	5/15/20

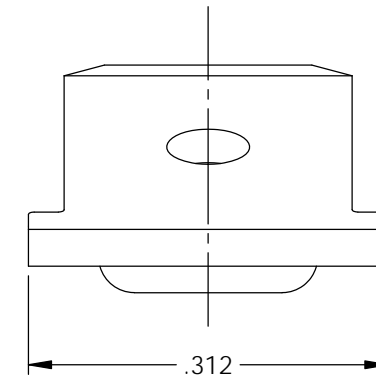
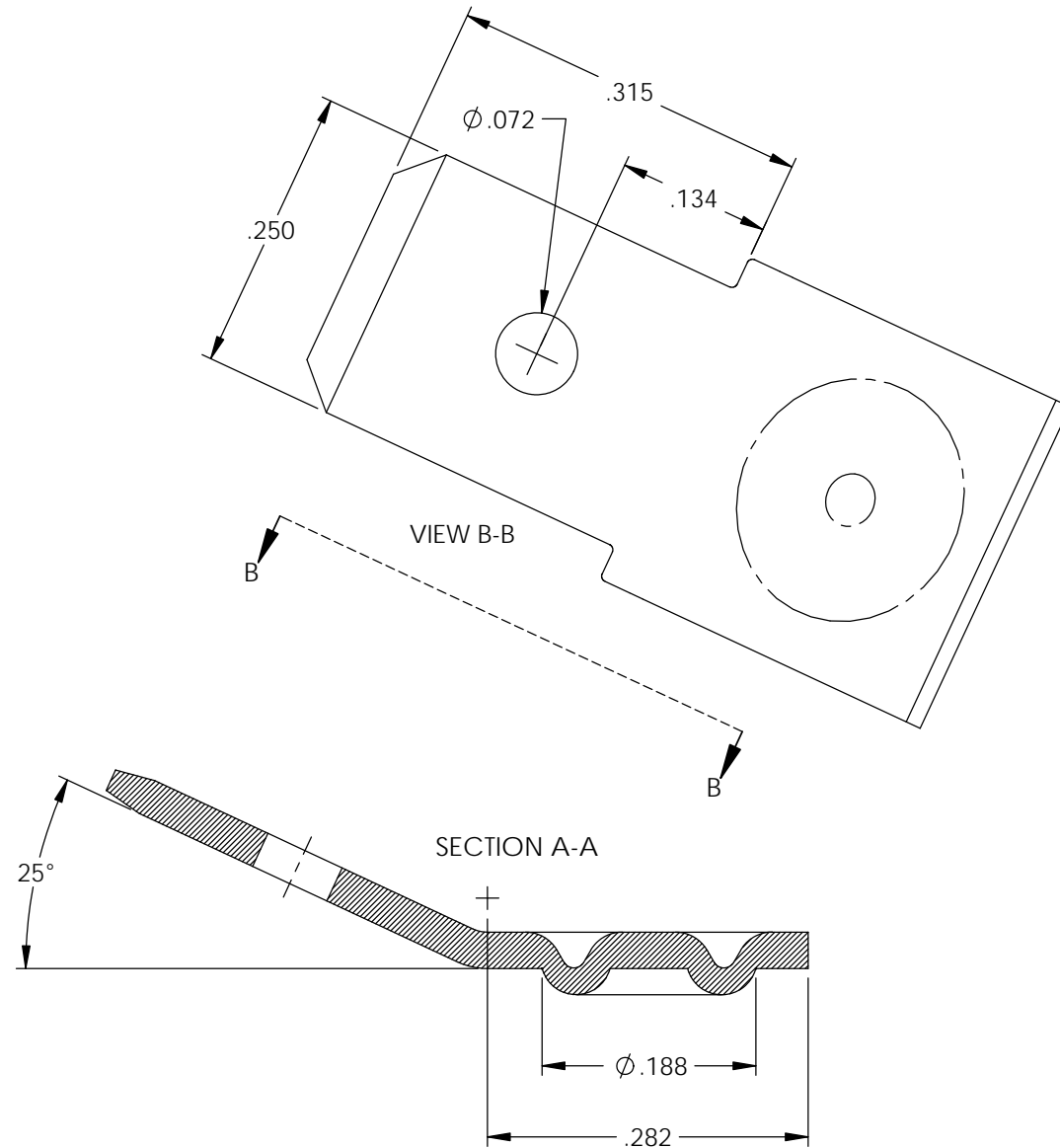

UNCONTROLLED COPY

<p>THIRD ANGLE PROJECTION TOLERANCES UNLESS OTHERWISE SPECIFIED INCHES: .XX - ±.030 .XXX - ±.015 ANGLES: ±5°</p>	<p>TOOL NO. 1050</p>	<p>Title: Stationary Weld Male</p>		
		<p>DO NOT SCALE DWG.</p>	<p>Drawn By: S.Johnson</p>	<p>Date: 5/15/20</p>
<p>ETCO Incorporated Engineered Products 25 Bellows Street Warwick, RI 02888 Phone: (401) 467-2400 Fax: (401) 467-9230 www.ETCO.com</p>		<p>Design Control By: ETCO</p>	<p>Scale: 6X</p>	<p>Size B</p>
<p>Dwg. No.: 3000M 292C3 cust</p>				