



P/C	DESCRIPTION	TERMINAL P/C	TERMINAL MAT'L & FINISH	INSULATOR P/C	INSULATOR MAT'L	INSULATOR TEMPERATURE RATING		
30166	PD263N-FR-TPB	07991	PRE-TINNED PHOSPHOR BRONZE	81122	6/6 NYLON FR	150° C MAX	X	X
30167	PD263N-FR-TPB-BLK	07991	PRE-TINNED PHOSPHOR BRONZE	81091	6/6 NYLON FR - Black	150° C MAX	X	X

Rev.	Description of Change/ SCN#	Date
-	INITIAL RELEASE SCJ	9/22/14
1	ECR# 3327 SCJ	10/03/14
2	ECR# 3649 SCJ	4/07/15
3	ECR# 3755 SCJ	6/11/15
3	ECR# 3817 SCJ	7/16/15

- NOTES:
1.) ACCEPTED MALE: .032 X .250 TAB.
2.) WIRE RANGE: 10-14 AWG.
3.) INSUL RANGE: ϕ .125-.180. (1)
4.) A RED INK IDENTIFYING MARK IS TO BE APPLIED TO THE INSULATOR APPROXIMATELY (3) AS SHOWN.
5.) INSULATOR TEMP RATING: 150°C MAX.
6.) VOLTAGE RATING: 600 V MAX, 1000 V MAX if used inside a fixture or sign. (3)



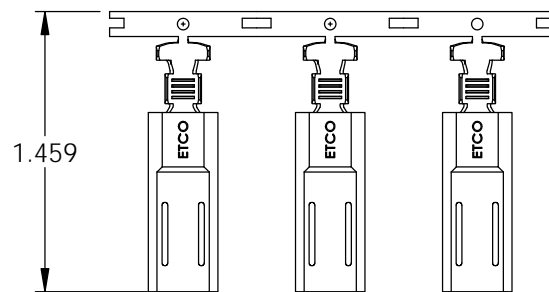
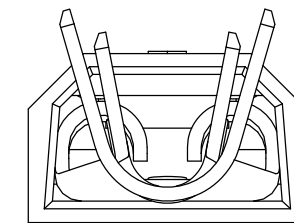
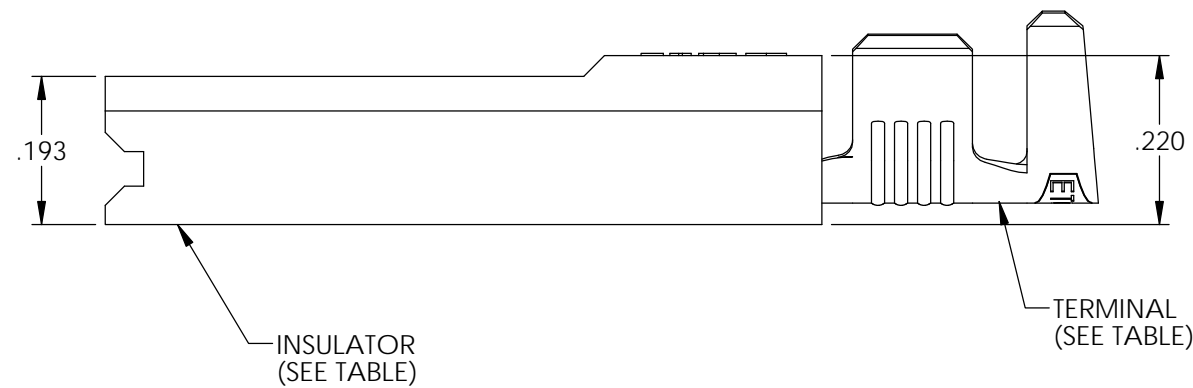
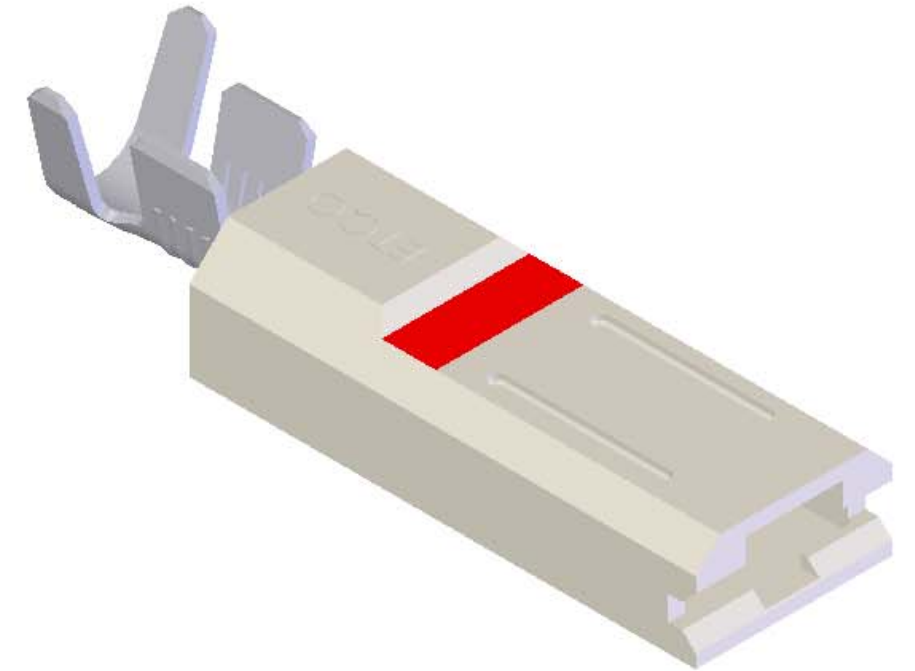
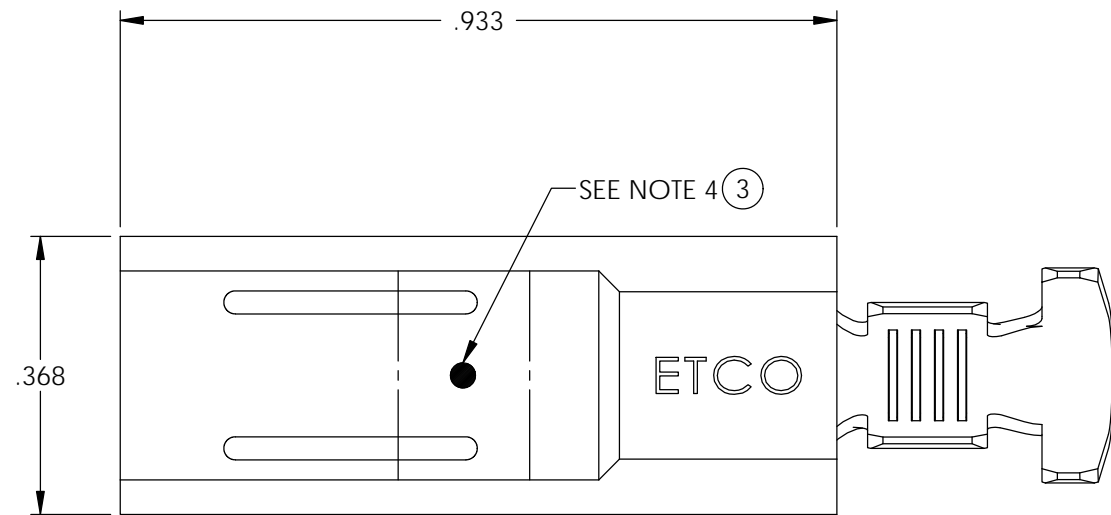

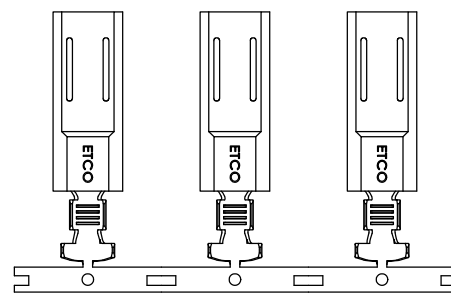
DIRECTION EXITING ASSEMBLY EQUIPMENT, EARS UP, INSULATOR TO THE FRONT

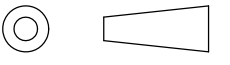

DIRECTION TOWARDS APPLICATOR, EARS UP, INSULATOR TO THE BACK

UNCONTROLLED COPY

 THIRD ANGLE PROJECTION TOLERANCES UNLESS OTHERWISE SPECIFIED INCHES: .XX - \pm .030 .XXX - \pm .015 ANGLES: \pm 5°	TOOL NO. 0797	Title: .032 X .250 INSULATED DISCONNECT ASSEMBLY	
		DO NOT SCALE DWG. Drawn By: S.Johnson Date: 1-10-07	Scale: 4X Size B
		Dwg. No.: PD263N-TPB cust	
		ETCO Incorporated Engineered Products 25 Bellows Street Warwick, RI 02888 Phone: (401) 467-2400 Fax: (401) 467-9230 www.ETCO.com	